

Modular Machine Free Vise

MODULAR VISES are manufactured under rigid quality control. Only the most suitable materials are used, and the accuracy of even the smallest components is assured. As a result of the high standard construction MODULAR VISES can be depended upon to maintain their accuracy under the most severe operating conditions.

MACHINE FREE VISE

L TYPE VISE

VMP-4L, 5L, 6L, 7L

NEW

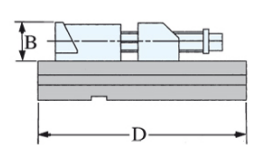
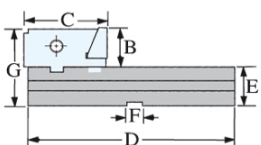
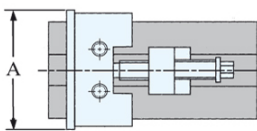
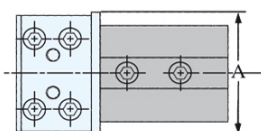
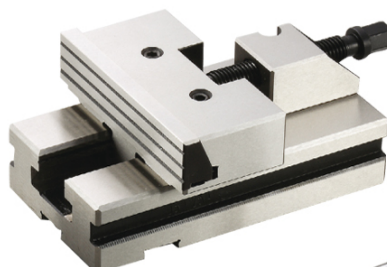

VMP-4L, 5L, 6L, 7L



Free head stock & fixed stock can for large wider workpiece use.

D TYPE VISE

VMP-44D / 55D / 66D / 77D

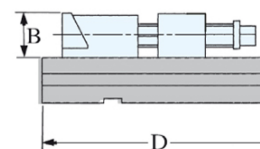
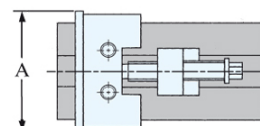
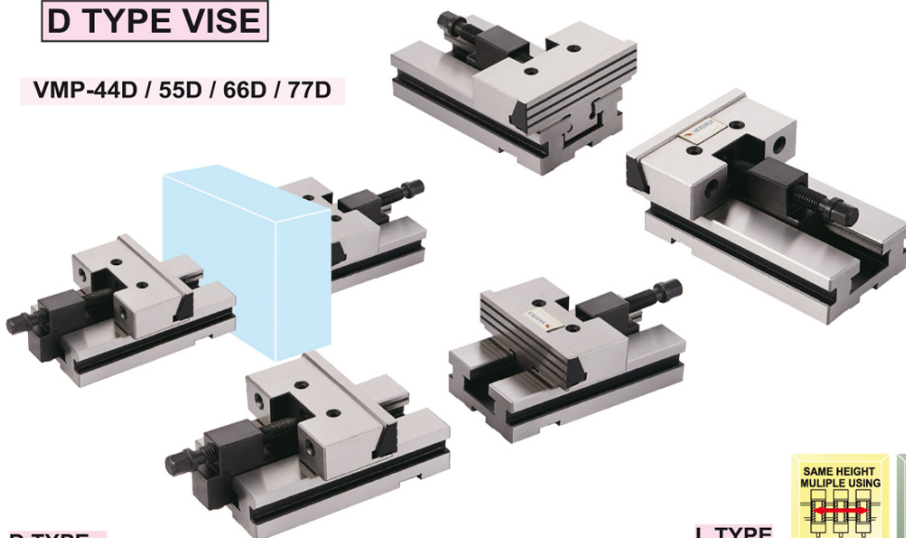

D TYPE

ORDER NO.	VMP-44D	VMP-55D	VMP-66D	VMP-77D
A	100	125	150	175
B	30	40	50	60
C	78	78	90	97
D	140	160	230	240
E	35	40	50	58
F	16	16	16	16
G	65	80	100	118
KGS	8.5	14.5	30.1	42.4
CODE NO.	1002-206D	1002-207D	1002-208D	1002-209D

L TYPE



ORDER NO.	VMP-4L	VMP-5L	VMP-6L	VMP-7L
A	100	125	150	175
B	30	40	50	60
C	78	78	90	97
D	140	160	230	240
E	35	40	50	58
F	16	16	16	16
G	65	80	100	118
KGS	8.5	14.5	30.1	42.4
CODE NO.	1002-206	1002-207	1002-208	1002-209