

COPA MANDRIL MANUAL INDEPENDIENTE DE 4 MORDAZAS 3-855-2000P



Selling Unit		EA
Chuck Type		Independent
Chuck Size	in	20
Body Material		Forged Steel
Number of Jaws		4
Jaw Type		2pc
Weight	lb	333
Mount Type		Front
Max RPM	RPM	700

DIAMETRO 20" 500MM

Diameter D	in	19.686
Recess Diameter B	in	10.6299
Recess Depth C	in	0.4724
Hole Diameter E	in	4.9213
Bolt Circle Diameter F	in	9.252
Body Height H	in	4.2126
Jaw Height H1 (Two-piece Jaws)	in	3.8504
Hole Thread Size S		4xM20

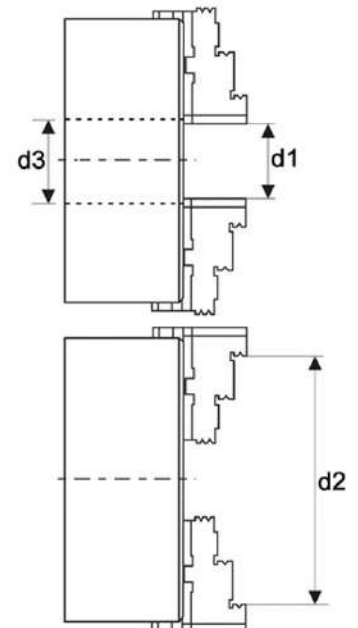
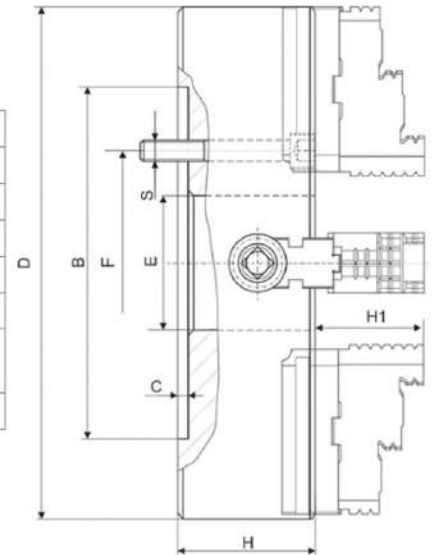

d1 Min	in	1.772
d2 Max	in	19.685
Chuck Thru Hole d3	in	4.9213