

**COPAS MANDRIL MANUAL INDEPENDIENTE DE 4 MORDAZAS 3-855-4800P**



Selling Unit		EA
Chuck Type		Independent
Chuck Size	in	48
Body Material		Forged Steel
Number of Jaws		4
Jaw Type		2pc
Weight	lb	2300
Mount Type		Front
Max RPM	RPM	509

Diameter D	in	47.244
Recess Diameter B	in	11.811
Recess Depth C	in	0.2756
Hole Diameter E	in	6.2992
Bolt Circle Diameter F	in	9.8425
Body Height H	in	5.7086
Jaw Height H1 (Two-piece Jaws)	in	3.5827
Hole Thread Size S		8xM24

**DIAMETRO 48" 1200MM**

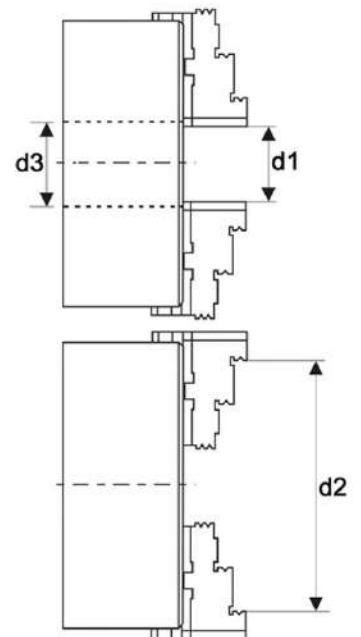
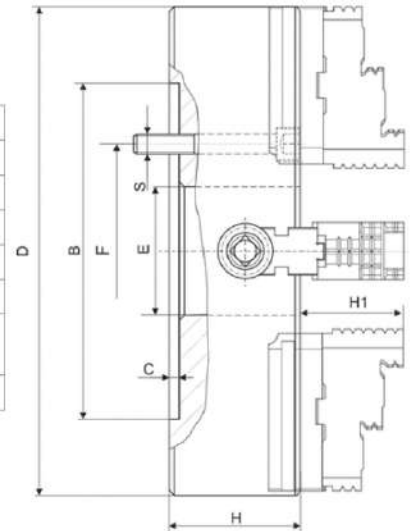

d1 Min	in	6.693
d2 Max	in	49.213
Chuck Thru Hole d3	in	6.2992